

B Bedienung

Operation – Manipulation

F1

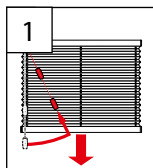

F3

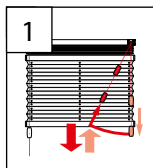

F5

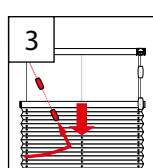
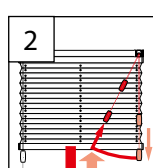
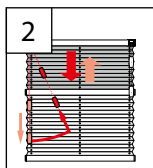
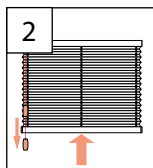
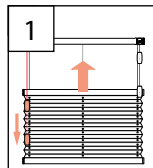
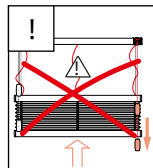

C Demontage

Dismantling – Démontage

DECKENCLIP

CEILING CLIP – CLIP PLAFOND

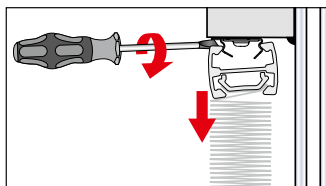

WANDWINKEL

WALL FIXING BRACKET – SUPPORT MURAL

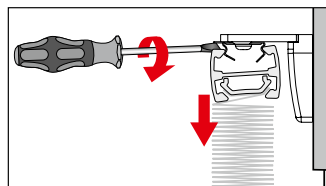

7



Achtung

Attention – Attention

Kinder können sich in den Schlingen von Schnüren, Ketten oder Gurten zur Bedienung von Sicht- und Sonnenschutzeinrichtungen verfangen oder sich Schnüre um den Hals wickeln und sich unter Umständen dadurch strangulieren. Schnüre, Ketten und Gurte sind außer Reichweite von Kindern zu halten, um Verwicklungen und Strangulierungen zu vermeiden. Betten, Kinderbetten und Möbel sind entfernt von Bedienungen für Sicht- und Sonnenschutzeinrichtungen aufzustellen.

Children can get caught in the loops of cords, chains or straps that operate window coverings or they can wrap cords around their necks and strangle thereby. Keep cords, chains and straps out of reach of children to avoid entanglement and strangulation. Move beds, cots and furniture away from window covering operations.

Les enfants peuvent se prendre dans cordons, chaînes ou courroies qui actionnent les stores de protection solaire et visuelle ou ils peuvent enrouler les cordons autour leur cou et ainsi s'étouffer. Maintenez les cordons, chaînes et courroies hors de portée des enfants pour éviter de s'étouffer ou de s'emmêler. Placez les lits, berceaux et meubles à l'écart des manipulations des stores de protection solaire et visuelle.

entspricht EN 13120
according to EN 13120 – selon EN 13120

02 / 2021

technische Änderungen bleiben
vorbehalten
subject to technical change
sous réserve de modifications techniques

PlisseeS
Pleated blinds – Stores plissés



F1, F3, F5

Montage- und Bedienanleitung

Assembly and operating instructions
Notice de montage et mode d'emploi

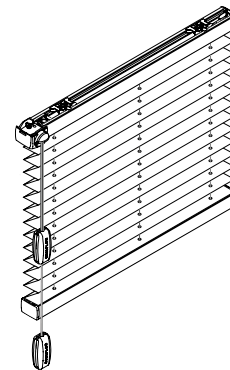

0404604644497

A Montage

Fixation – Montage

→ **Bitte nur beiliegende Schrauben verwenden!**

Please use only the enclosed screws! - Veuillez utiliser seulement les vis jointes!

DECKENCLIP

CEILING CLIP – CLIP PLAFOND

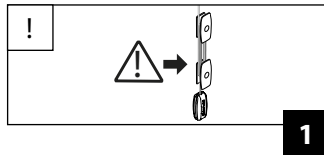
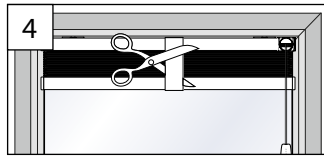
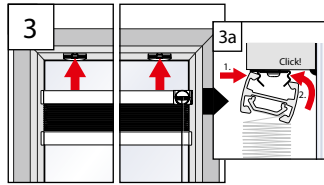
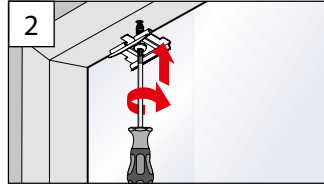
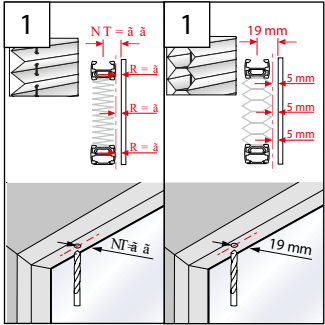
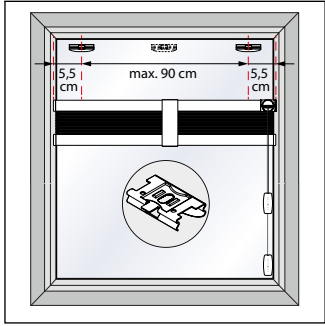

WANDWINKEL

WALL FIXING BRACKET – SUPPORT MURAL

